

1.25A Low Dropout Voltage Regulator

Features

- High Output Voltage Accuracy
- Guaranteed 1.25A Output
- Low Quiescent Current
- Low Dropout Voltage
- Extremely Tight Load and Line Regulation
- Very Low Temperature Coefficient
- Current and Thermal Limiting
- Input Can Withstand –20V Reverse Battery and +60V Positive Transients
- Logic-Controlled Electronic Shutdown
- Output Programmable from 1.24V to 26V (MIC2941A)
- Available in TO-220-3, TO-263-3, TO-220-5, and TO-263-5 Packages

Applications

- Battery-Powered Equipment
- Cellular Telephones
- Laptop, Notebook, and Palmtop Computers
- PCMCIA V_{CC} and V_{PP} Regulation/Switching
- Barcode Scanners
- Automotive Electronics
- SMPS Post-Regulator/DC-to-DC Modules
- Voltage Reference
- High Efficiency Linear Power Supplies

General Description

The MIC2940A and MIC2941A are “bulletproof” efficient voltage regulators with very low dropout voltage (typically 40 mV at light loads and 350 mV at 1A), and low quiescent current (240 μ A typical). The quiescent current of the MIC2940A increases only slightly in dropout, thus prolonging battery life. Key MIC2940A features include protection against reversed battery, fold-back current-limiting, and automotive “load dump” protection (60V positive transient).

The MIC2940A is available in both fixed voltage (3.3V, 5V, and 12V) and adjustable voltage configurations. The MIC2940A-xx devices are three pin, fixed-voltage regulators. A logic-compatible shutdown input is provided on the adjustable MIC2941A, which enables the regulator to be switched on and off.

Package Types

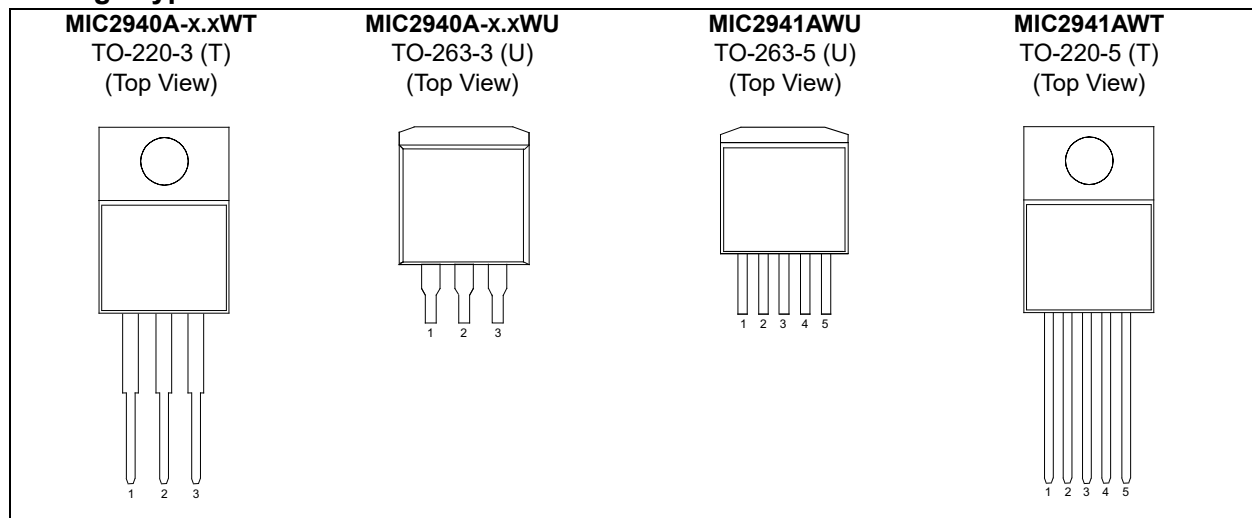

MIC2940A/41A

Typical Application Circuits

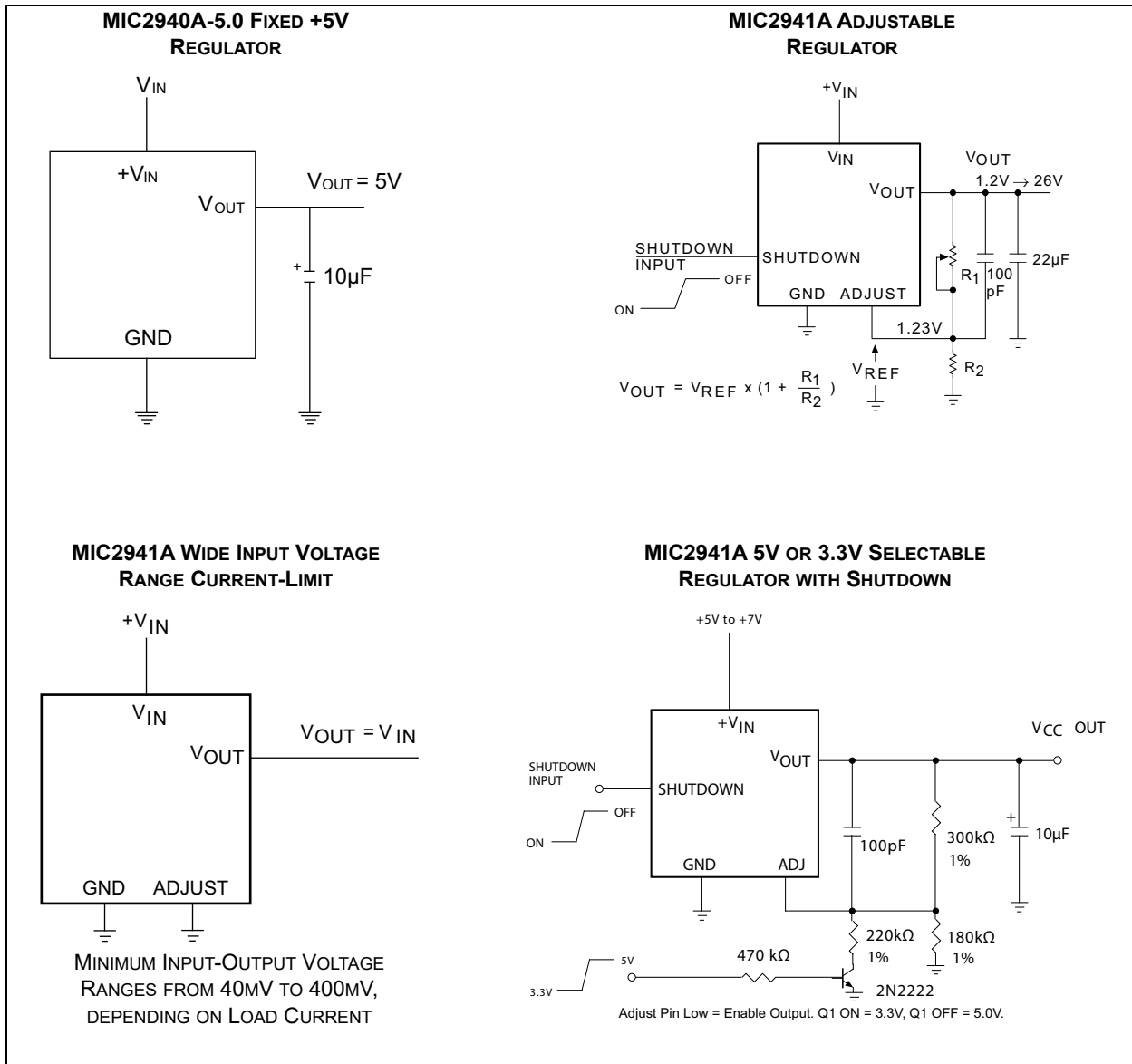

Functional Block Diagram

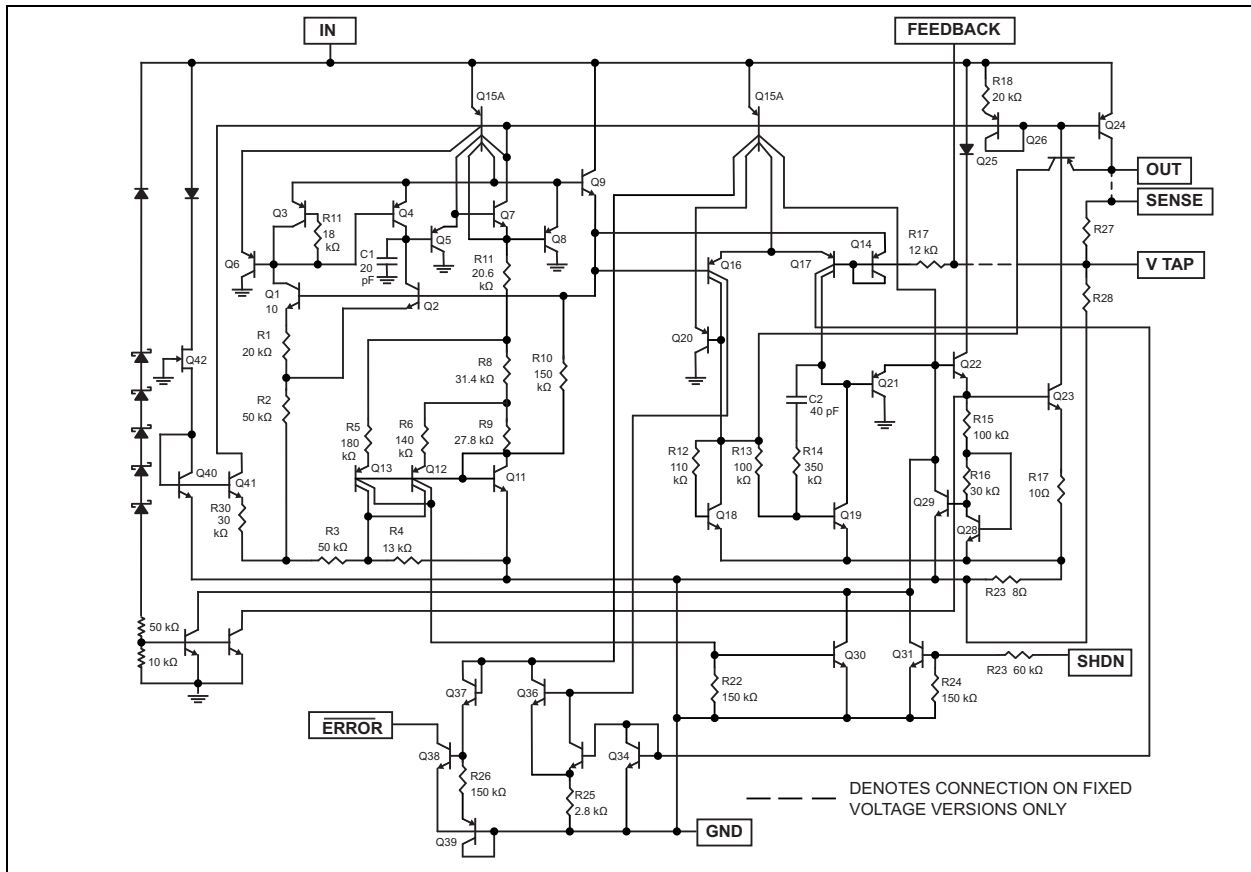

MIC2940A/41A

1.0 ELECTRICAL CHARACTERISTICS

Absolute Maximum Ratings †

Power Dissipation (P_D).....	Internally Limited, Note 1
Input Supply Voltage	-20V to +60V
Adjust Input Voltage (Note 2 , Note 3).....	-1.5V to +26V
Shutdown Input Voltage	-0.3V to +30V
Error Comparator Output Voltage.....	-0.3V to +30V

Operating Ratings ‡

Input Supply Voltage (Note 4)	+2V to +26V
---	-------------

† **Notice:** Stresses above those listed under “Absolute Maximum Ratings” may cause permanent damage to the device. This is a stress rating only and functional operation of the device at those or any other conditions above those indicated in the operational sections of this specification is not intended. Exposure to maximum rating conditions for extended periods may affect device reliability.

‡ **Notice:** The device is not guaranteed to function outside its operating ratings.

Note 1: The maximum allowable power dissipation of any T_A (ambient temperature) is $P_{D(max)} = (T_{J(max)} - T_A)/\theta_{JA}$. Exceeding the maximum allowable power dissipation will result in excessive die temperature, and the regulator will go into thermal shutdown.

2: Circuit of MIC2941A Adjustable Regulator in the [Typical Application Circuits](#) section (upper right) with $R1 \geq 150 \text{ k}\Omega$. $V_{SHUTDOWN} \geq 2V$ and $V_{IN} \leq 26V$, $V_{OUT} = 0$.

3: When used in dual supply systems where the regulator load is returned to a negative supply, the output voltage must be diode clamped to ground.

4: Across the full operating temperature, the minimum input voltage range for full output current is 4.3V to 26V. Output will remain in regulation at lower output voltages and low current loads down to an input of 2V at 25°C.

ELECTRICAL CHARACTERISTICS

Electrical Characteristics: Limits in standard typeface are for $T_J = +25^\circ\text{C}$ and limits in **boldface** apply over the full operating temperature range. Unless otherwise specified, $V_{IN} = V_{OUT} + 1V$, $I_L = 1000 \text{ mA}$, $C_L = 10 \mu\text{F}$. The MIC2941A is programmed to output 5V and has $V_{SHUTDOWN} 0.6V$.

Parameter	Symbol	Min.	Typ.	Max.	Units	Conditions
Output Voltage Accuracy	V_O	-1	—	1	%	—
		-2	—	2		—
		-2.5	—	2.5		$5\text{mA} \leq I_L \leq 1\text{A}$
Output Voltage Temperature Coefficient	$\Delta V_O/\Delta T$	—	20	100	ppm/°C	Note 1
Line Regulation	$\Delta V_O/V_O$	—	0.06	0.50	%	$I_O = 10 \text{ mA}$, $(V_{OUT} + 1V) \leq V_{IN} \leq 26V$
Load Regulation		—	0.04	0.16		$I_L = 5 \text{ mA to } 1.25\text{A}$
		—	—	0.20		$I_L = 5 \text{ mA to } 1\text{A}$, Note 2
Dropout Voltage, Note 3	$V_{IN} - V_O$	—	60	150	mV	$I_L = 5 \text{ mA}$
		—	—	180		$I_L = 250 \text{ mA}$
		—	200	250		
		—	—	320		$I_L = 1000 \text{ mA}$
		—	350	450		
		—	—	600		$I_L = 1250 \text{ mA}$
—	400	600				

ELECTRICAL CHARACTERISTICS (CONTINUED)

Electrical Characteristics: Limits in standard typeface are for $T_J = +25^\circ\text{C}$ and limits in **boldface** apply over the full operating temperature range. Unless otherwise specified, $V_{IN} = V_{OUT} + 1\text{V}$, $I_L = 1000\text{ mA}$, $C_L = 10\text{ }\mu\text{F}$. The MIC2941A is programmed to output 5V and has $V_{SHUTDOWN} 0.6\text{V}$.

Parameter	Symbol	Min.	Typ.	Max.	Units	Conditions
Ground Pin Current, Note 4	I_{GND}	—	240	500	μA	$I_L = 5\text{ mA}$
		—	3	4.5	mA	$I_L = 250\text{ mA}$
		—	—	6		
		—	22	35		
		—	—	45		
		—	35	70		
Ground Pin Current at Dropout, Note 4	I_{GNDDO}	—	330	600	μA	$V_{IN} = 0.5\text{V}$ less than designed V_{OUT} ($V_{OUT} 3.3$), $I_L = 5\text{ mA}$
Current-Limit	I_{LIMIT}	—	1.6	3.5	A	$V_{OUT} = 0\text{V}$, Note 5
Thermal Regulation	$\Delta V_O/\Delta P_D$	—	0.05	0.2	%/W	Note 6
Output Noise Voltage (10 Hz to 100 kHz) $I_L = 100\text{ mA}$	e_n	—	400	—	μV_{RMS}	$C_L = 10\text{ }\mu\text{F}$
		—	260	—		$C_L = 33\text{ }\mu\text{F}$
Electrical Characteristics for MIC2941A Only						
Reference Voltage	V_{REF}	1.223	1.235	1.247	V	Note 7
		1.210	—	1.260		
		1.204	—	1.266		
Adjust Pin Bias Current	I_{BIAS}	—	20	40	nA	—
		—	—	60		
Reference Voltage Temperature Coefficient	$\Delta V_{REF}/\Delta T$	—	20	—	ppm/ $^\circ\text{C}$	—
Adjust Pin Bias Current Temperature Coefficient	$\Delta I_{BIAS}/\Delta T$	—	0.1	—	nA/ $^\circ\text{C}$	—

MIC2940A/41A

ELECTRICAL CHARACTERISTICS (CONTINUED)

Electrical Characteristics: Limits in standard typeface are for $T_J = +25^\circ\text{C}$ and limits in **boldface** apply over the full operating temperature range. Unless otherwise specified, $V_{IN} = V_{OUT} + 1\text{V}$, $I_L = 1000\text{ mA}$, $C_L = 10\text{ }\mu\text{F}$. The MIC2941A is programmed to output 5V and has $V_{SHUTDOWN} = 0.6\text{V}$.

Parameter	Symbol	Min.	Typ.	Max.	Units	Conditions
Shutdown Input						
Input Logic Voltage	V_{IL}	—	1.3	0.7	V	Low (ON)
	V_{IH}	2.0	—	—		High (OFF)
Shutdown Pin Input Current	I_{SHDN}	—	30	50	μA	$V_{SHUTDOWN} = 2.4\text{V}$
		—	—	100		
		—	450	600		$V_{SHUTDOWN} = 26\text{V}$
		—	—	750		
Regulator Output Current in Shutdown	$I_{OUT(SHDN)}$	—	3	30	μA	Note 8
		—	—	60		

- Note 1:** Output voltage temperature coefficient is defined as the worst case voltage change divided by the total temperature range.
- 2:** Regulation is measured at constant junction temperature using low duty cycle pulse testing. Changes in output voltage due to heating effects are covered by the thermal regulation specification.
- 3:** Dropout voltage is defined as the input to output differential at which the output voltage drops 100 mV below its nominal value measured at 1V differential. At low values of programmed output voltage, the minimum input supply voltage of 4.3V over temperature must be taken into account.
- 4:** Ground pin current is the regulator quiescent current. The total current drawn from the source is the sum of the load current plus the ground pin current.
- 5:** The MIC2940A features fold-back current limiting. The short-circuit ($V_{OUT} = 0\text{V}$) current-limit is less than the maximum current with normal output voltage.
- 6:** Thermal regulation is defined as the change in output voltage at a time (T) after a change in power dissipation is applied, excluding load or line regulation effects. Specifications are for a 200 mA load pulse at $V_{IN} = 20\text{V}$ (a 4W pulse) for $T = 10\text{ ms}$.
- 7:** $V_{REF} \leq V_{OUT} \leq (V_{IN} - 1\text{V})$, $4.3\text{V} \leq V_{IN} \leq 26\text{V}$, $5\text{ mA} < I_L \leq 1.25\text{A}$, $T_J \leq T_{J(MAX)}$.
- 8:** When used in dual supply systems where the regulator load is returned to a negative supply, the output voltage must be diode clamped to ground.

TEMPERATURE SPECIFICATIONS (Note 1)

Parameters	Sym.	Min.	Typ.	Max.	Units	Conditions
Temperature Ranges						
Storage Temperature Range	T_S	-65	—	+150	°C	—
Junction Operating Temperature Range	T_J	-40	—	+125	°C	—
Lead Temperature	—	—	—	+260	°C	Soldering, 5s
Package Thermal Resistances						
Thermal Resistance TO-220	θ_{JC}	—	2	—	°C/W	—
Thermal Resistance TO-263	θ_{JC}	—	2	—	°C/W	—

Note 1: The maximum allowable power dissipation is a function of ambient temperature, the maximum allowable junction temperature and the thermal resistance from junction to air (i.e., T_A , T_J , θ_{JA}). Exceeding the maximum allowable power dissipation will cause the device operating junction temperature to exceed the maximum +125°C rating. Sustained junction temperatures above +125°C can impact the device reliability.

MIC2940A/41A

2.0 TYPICAL PERFORMANCE CURVES

Note: The graphs and tables provided following this note are a statistical summary based on a limited number of samples and are provided for informational purposes only. The performance characteristics listed herein are not tested or guaranteed. In some graphs or tables, the data presented may be outside the specified operating range (e.g., outside specified power supply range) and therefore outside the warranted range.

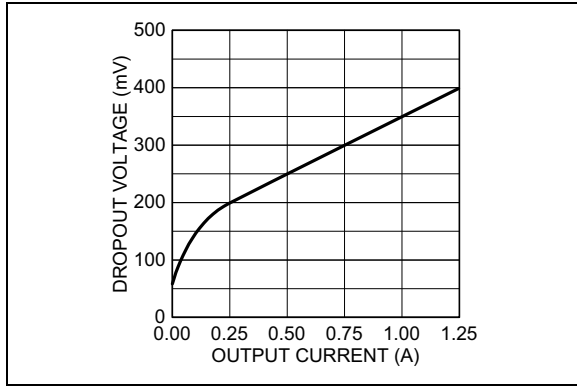

FIGURE 2-1: Dropout Voltage vs. Output Current.

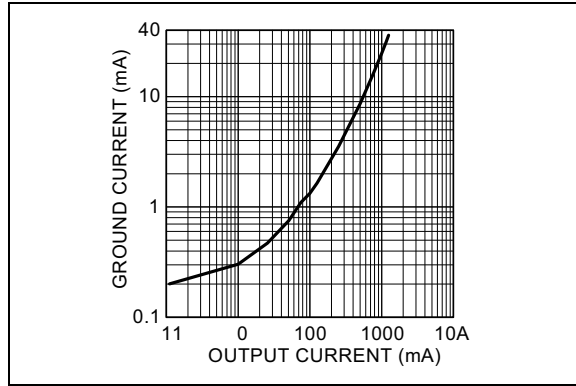

FIGURE 2-4: Ground Current vs. Output Current.

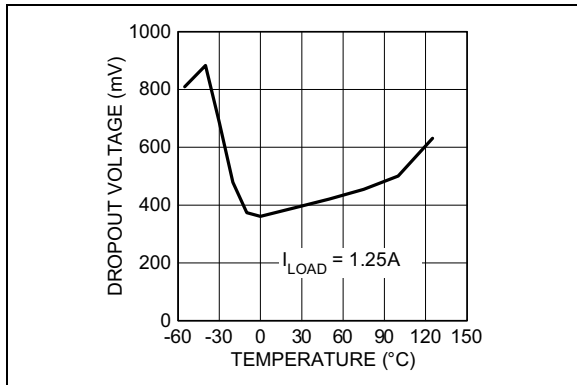

FIGURE 2-2: Dropout Voltage vs. Temperature.

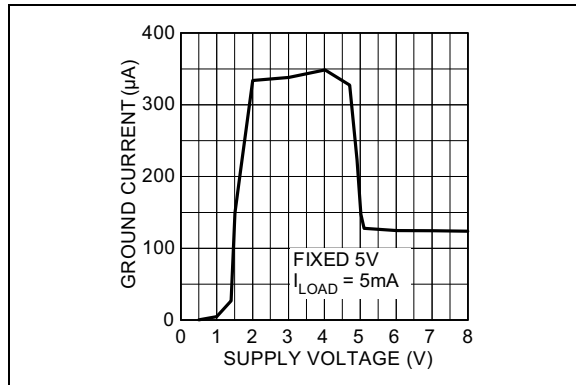

FIGURE 2-5: Ground Current vs. Supply Voltage.

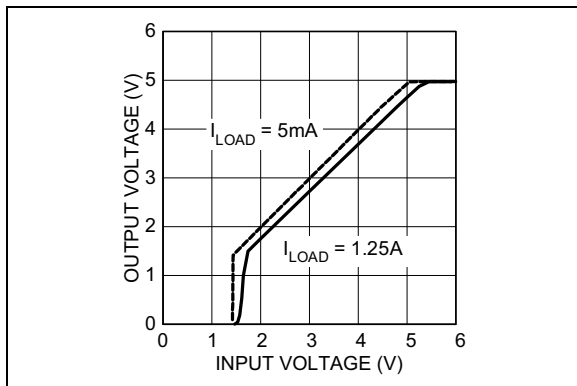

FIGURE 2-3: Dropout Characteristics.

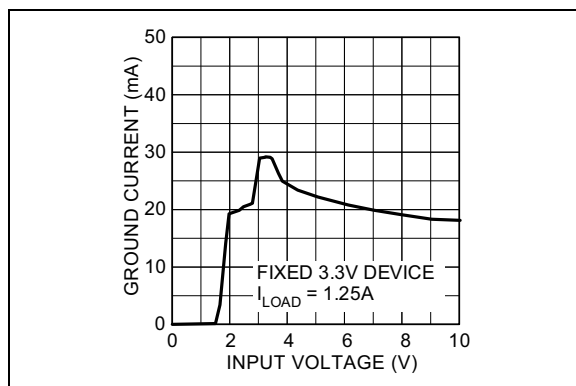

FIGURE 2-6: Ground Current vs. Supply Voltage.

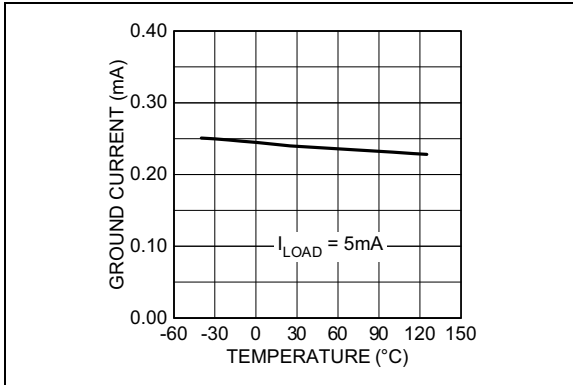

FIGURE 2-7: Ground Current vs. Temperature.

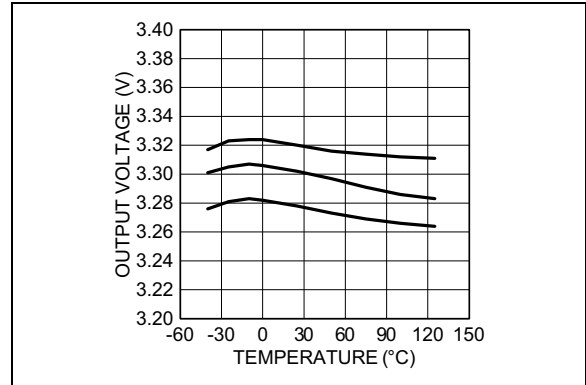

FIGURE 2-10: Fixed 3.3V Output Voltage vs. Temperature.

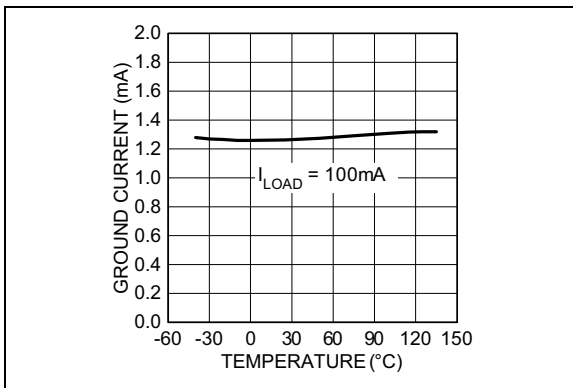

FIGURE 2-8: Ground Current vs. Temperature.

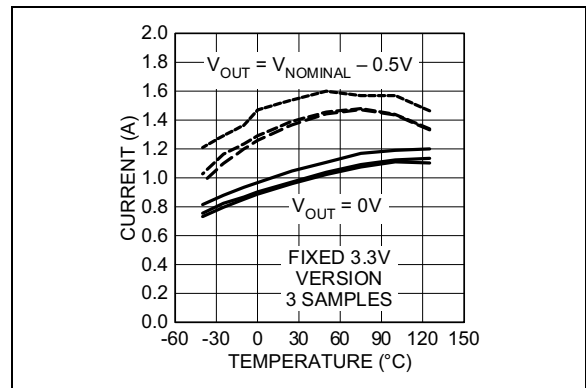

FIGURE 2-11: Short-Circuit and Maximum Current vs. Temperature.

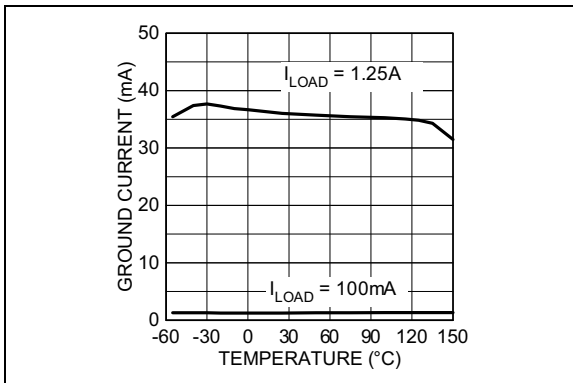

FIGURE 2-9: Ground Current vs. Temperature.

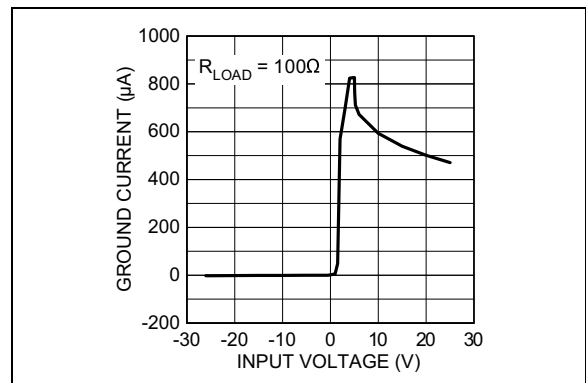

FIGURE 2-12: Ground Current vs. Input Voltage.

MIC2940A/41A

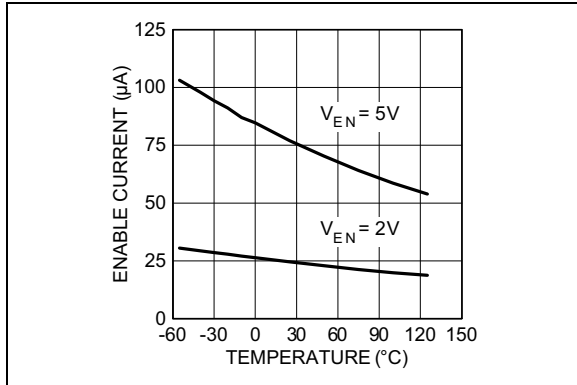

FIGURE 2-13: MIC2941A Shutdown Current vs. Temperature.

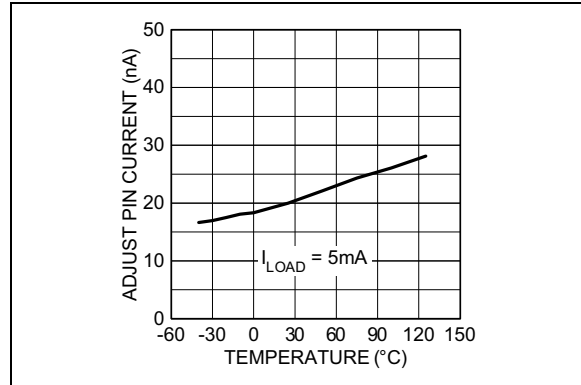

FIGURE 2-16: MIC2941A Adjust Pin Current vs. Temperature.

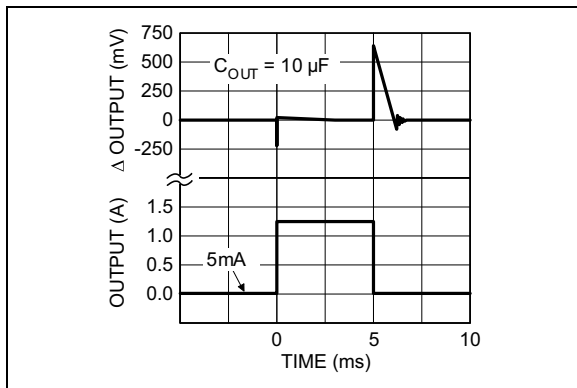

FIGURE 2-14: Load Transient.

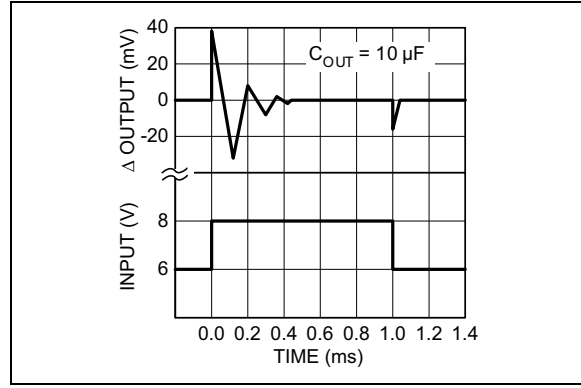

FIGURE 2-17: Line Transient.

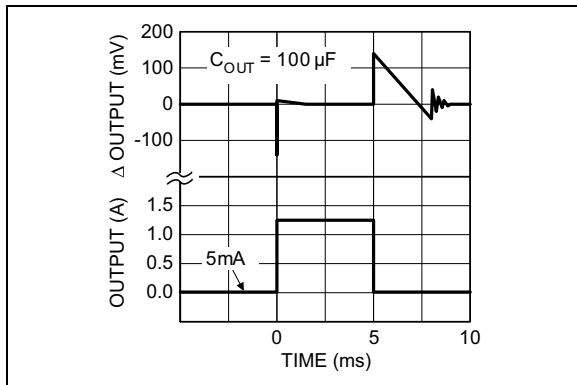

FIGURE 2-15: Load Transient.

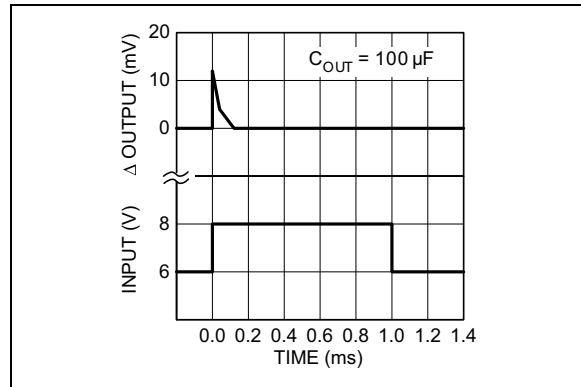

FIGURE 2-18: Line Transient.

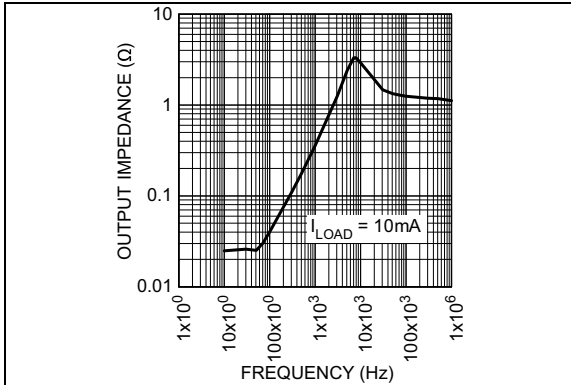

FIGURE 2-19: *Output Impedance vs. Frequency.*

MIC2940A/41A

3.0 PIN DESCRIPTIONS

The descriptions of the pins are listed in [Table 3-1](#).

TABLE 3-1: PIN FUNCTION TABLE

MIC2940A Pin Number	MIC2941A Pin Number	Pin Name	Description
1	4	Input	Unregulated input supply.
2	3	Ground	Ground.
3	5	Output	Regulated output voltage.
—	1	Adjust	Adjust (input): Connect to an external resistor voltage divider to set the output voltage.
—	2	Shutdown	Shutdown/Enable (input): Logic level low = Enable. Logic level high = Shutdown.

4.0 APPLICATION INFORMATION

4.1 External Capacitors

A 10 μF (or greater) capacitor is required between the MIC2940A output and ground to prevent oscillations due to instability. Most types of tantalum or aluminum electrolytics will be adequate; film types will work, but are costly and therefore not recommended. Many aluminum electrolytics have electrolytes that freeze at about -30°C , so solid tantalums are recommended for operation below -25°C . The important parameters of the capacitor are an effective series resistance of about 5Ω or less and a resonant frequency above 500 kHz. The value of this capacitor may be increased without limit.

At lower values of output current, less output capacitance is required for output stability. The capacitor can be reduced to 3.3 μF for current below 100 mA or 2.2 μF for currents below 10 mA. Adjusting the MIC2941A to voltages below 5V runs the error amplifier at lower gains so that more output capacitance is needed. For the worst-case situation of a 1.25A load at 1.23V output (Output shorted to Adjust) a 22 μF (or greater) capacitor should be used.

The MIC2940A will remain stable and in regulation with load currents ranging from 5 mA on up to the full 1.25A rating. The external resistors of the MIC2941A version may be scaled to draw this minimum load current.

A 0.22 μF capacitor should be placed from the MIC2940A input to ground if there is more than 10 inches of wire between the input and the AC filter capacitor or if a battery is used as the input.

4.2 Programming the Output Voltage (MIC2941A)

The MIC2941A may be programmed for any output voltage between its 1.235V reference and its 26V maximum rating. An external pair of resistors is required, as shown in the MIC2941A Adjustable Regulator Typical Application Circuit.

EQUATION 4-1:

$$V_{OUT} = V_{REF} \times \left(1 + \frac{R1}{R2}\right) - |I_{FB}| \times R1$$

Where:

V_{REF} = The nominal 1.235V reference voltage.

I_{FB} = The adjust pin bias current (nom. 20 nA).

The minimum recommended load current of 1 μA forces an upper limit of 1.2 M Ω on the value of R2, if the regulator must work with no load (a condition often found in CMOS in standby), I_{FB} will produce a -2% typical error in V_{OUT} which may be eliminated at room temperature by trimming R1. For better accuracy, choosing R2 = 100 k Ω reduces this error to 0.17%

while increasing the resistor program current to 12 μA . Because the MIC2941A typically draws 100 μA at no load with SHUTDOWN open-circuited, this is a negligible addition.

4.3 Reducing Output Noise

In reference applications, it may be advantageous to reduce the AC noise present at the output. One method is to reduce the regulator bandwidth by increasing the size of the output capacitor. This is relatively inefficient, as increasing the capacitor from 1 μF to 220 μF only decreases the noise from 430 μV to 160 μV_{RMS} for a 100 kHz bandwidth at 5V output. Noise can be reduced by a factor of four with the MIC2941A by adding a bypass capacitor across R1.

EQUATION 4-2:

$$C_{BYPASS} = \frac{1}{2\pi \times R1 \times 200\text{Hz}}$$

Pick a bypass capacitor of about 0.01 μF . When doing this, the output capacitor must be increased to 22 μF to maintain stability. These changes reduce the output noise from 430 μV to 100 μV_{RMS} for a 100 kHz bandwidth at 5V output. With the bypass capacitor added, noise no longer scales with output voltage so that improvements are more dramatic at higher output voltages.

4.4 Automotive Applications

The MIC2940A is ideally suited for automotive applications for a variety of reasons. It will operate over a wide range of input voltages with very low dropout voltages (40 mV at light loads), and very low quiescent currents (240 μA typical). These features are necessary for use in battery powered systems, such as automobiles. It is a "bulletproof" device with the ability to survive both reverse battery (negative transients up to 20V below ground), and load dump (positive transients up to 60V) conditions. A wide operating temperature range with low temperature coefficients is yet another reason to use these versatile regulators in automotive designs.

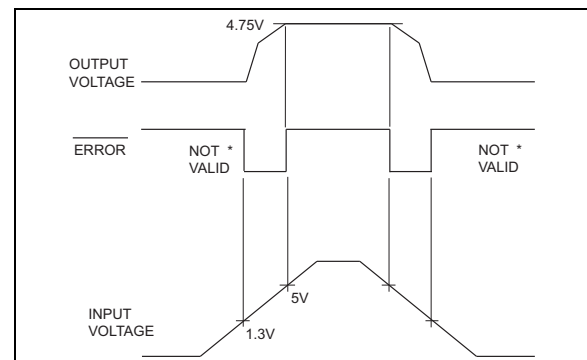
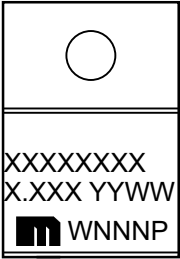
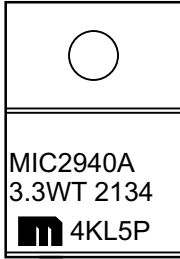
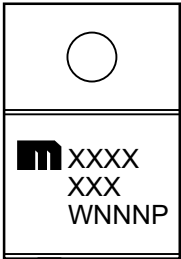
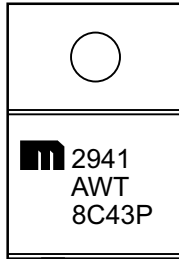





FIGURE 4-1: ERROR Output Timing.

MIC2940A/41A

5.0 PACKAGING INFORMATION

5.1 Package Marking Information

TO-220* (Fixed)	Example	TO-220* (Adj.)	Example
			
TO-263* (Fixed)	Example	TO-263* (Adj.)	Example
			

<p>Legend:</p> <ul style="list-style-type: none"> XX...X Product code or customer-specific information Y Year code (last digit of calendar year) YY Year code (last 2 digits of calendar year) WW Week code (week of January 1 is week '01') NNN Alphanumeric traceability code (e3) Pb-free JEDEC® designator for Matte Tin (Sn) * This package is Pb-free. The Pb-free JEDEC designator ((e3)) can be found on the outer packaging for this package. •, ▲, ▼ Pin one index is identified by a dot, delta up, or delta down (triangle mark).
<p>Note: In the event the full Microchip part number cannot be marked on one line, it will be carried over to the next line, thus limiting the number of available characters for customer-specific information. Package may or may not include the corporate logo.</p> <p>Underbar (_) and/or Overbar (¯) symbol may not be to scale.</p>

Note: If the full seven-character YYWWNNN code cannot fit on the package, the following truncated codes are used based on the available marking space:
 6 Characters = YWWNNN; 5 Characters = WWNNN; 4 Characters = WNNN; 3 Characters = NNN;
 2 Characters = NN; 1 Character = N

3-Lead TO-220 Package Outline and Recommended Land Pattern

TITLE

3 LEAD TO220 PACKAGE OUTLINE & RECOMMENDED LAND PATTERN

DRAWING #	TO220-3LD-PL-1	UNIT	INCH
Lead Frame	Copper Alloy	Lead Finish	Matte Tin

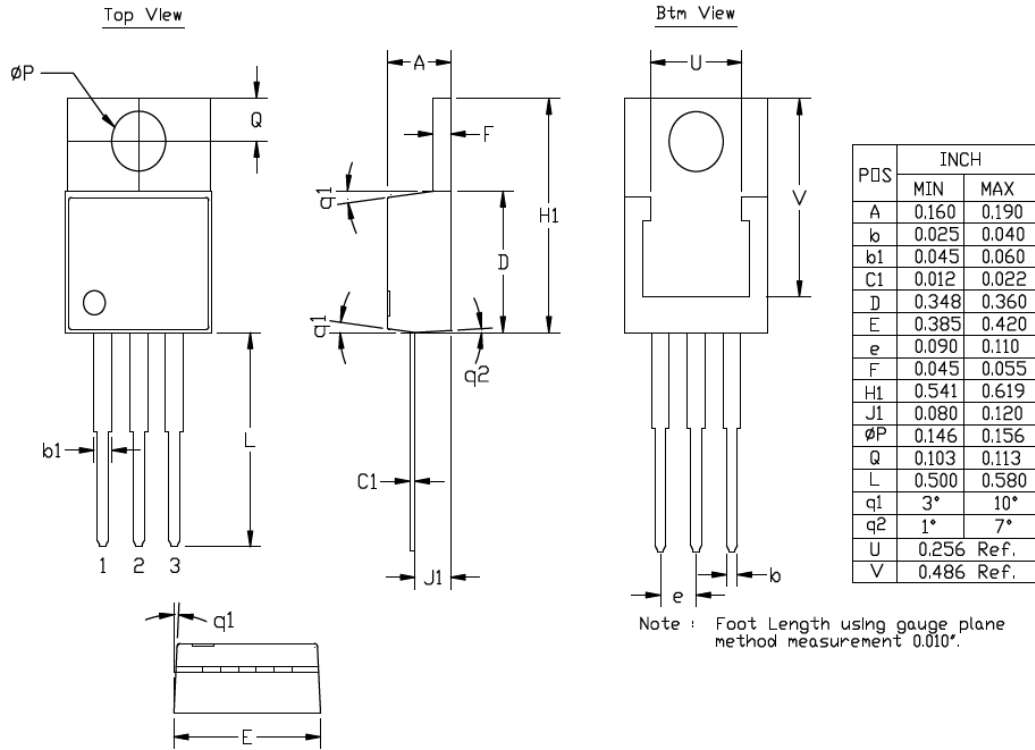

Note: For the most current package drawings, please see the Microchip Packaging Specification located at <http://www.microchip.com/packaging>.

MIC2940A/41A

3-Lead TO-263 Package Outline and Recommended Land Pattern

TITLE

3 LEAD TO263 PACKAGE OUTLINE & RECOMMENDED LAND PATTERN

DRAWING #	TO263-3LD-PL-1	UNIT	INCH/MM
------------------	----------------	-------------	---------

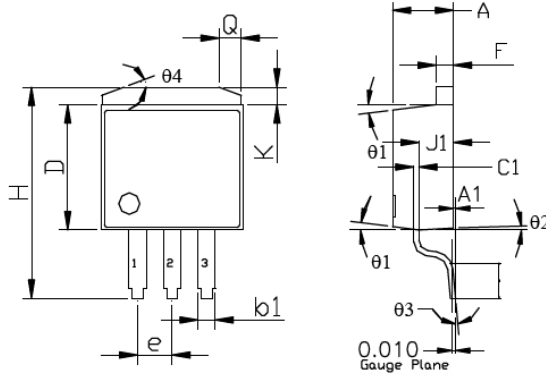

TOP VIEW

SIDE VIEW 1

POS	INCH		MM	
	MIN	MAX	MIN	MAX
A	0.170	0.181	4.318	4.597
A1	0.000	0.012	0.000	0.305
b1	0.047	0.053	1.194	1.346
C1	0.012	0.023	0.305	0.584
D	0.330	0.361	8.382	9.169
E	0.396	0.420	10.058	10.668
e	0.095	0.105	2.413	2.667
F	0.045	0.055	1.143	1.397
H	0.575	0.625	14.605	15.875
J1	0.080	0.120	2.032	3.048
L1	0.090	0.110	2.286	2.794
K	0.045	0.066	1.143	1.676
theta1	3°	10°	3°	10°
theta2	1°	7°	1°	7°
theta3	0°	8°	0°	8°
theta4	18°	22°	18°	22°
Q	0.055	0.075	1.397	1.905
U	0.256	Ref.	6.502	Ref.
V	0.303	Ref.	7.696	Ref.

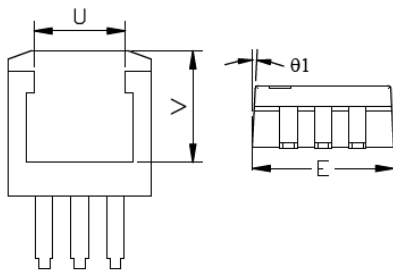

BOTTOM VIEW

SIDE VIEW 2

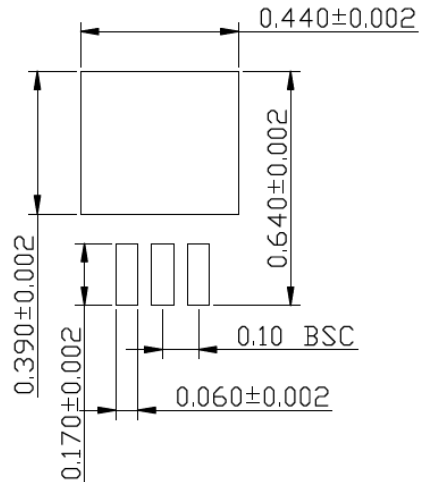

RECOMMENDED LAND PATTERN (UNIT: INCH)

NOTES:
FOOT LENGTH USE GAUGE PLANE METHOD MEASUREMENT 0.010"

Note: For the most current package drawings, please see the Microchip Packaging Specification located at <http://www.microchip.com/packaging>.

5-Lead TO-220 Package Outline and Recommended Land Pattern

TITLE

5 LEAD TO220 PACKAGE OUTLINE & RECOMMENDED LAND PATTERN

DRAWING #	TO220-5LD-PL-1	UNIT	INCH
Lead Frame	Copper Alloy	Lead Finish	Matte Tin

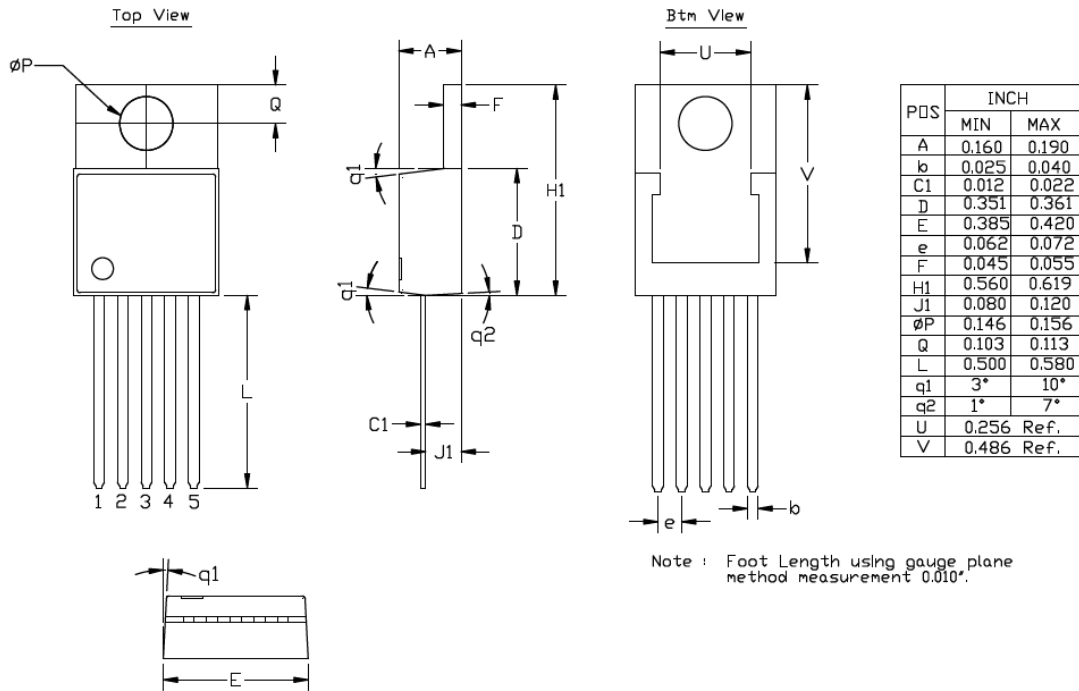

Note: For the most current package drawings, please see the Microchip Packaging Specification located at <http://www.microchip.com/packaging>.

MIC2940A/41A

5-Lead TO-263 Package Outline and Recommended Land Pattern

TITLE

5 LEAD T0263 PACKAGE OUTLINE & RECOMMENDED LAND PATTERN

DRAWING #	T0263-5LD-PL-1	UNIT	INCH/MM
------------------	----------------	-------------	---------

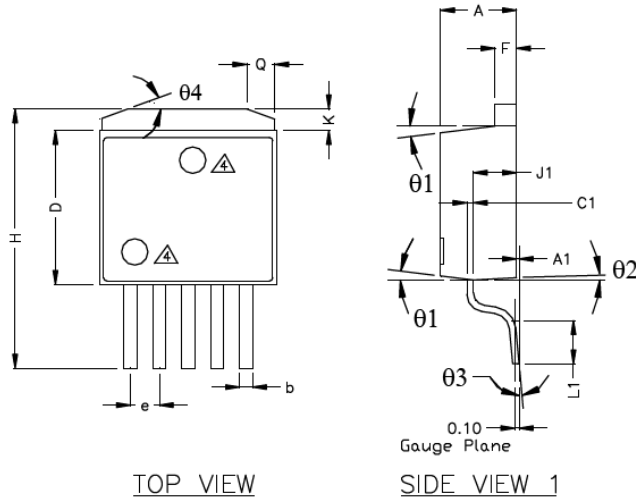

TOP VIEW

SIDE VIEW 1

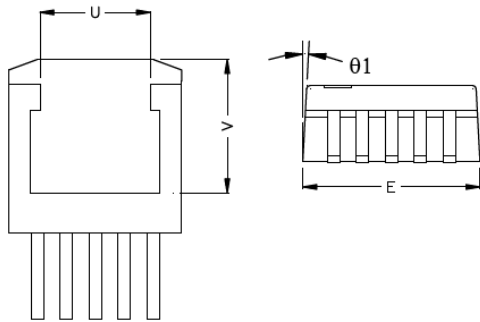

BOTTOM VIEW

SIDE VIEW 2

PDS	INCH		MM	
	MIN	MAX	MIN	MAX
A	0.170	0.181	4.318	4.597
A1	0.000	0.012	0.000	0.305
b	0.026	0.036	0.660	0.914
C1	0.012	0.023	0.305	0.584
D	0.330	0.361	8.392	9.169
E	0.396	0.420	10.058	10.668
e	0.062	0.072	1.575	1.829
F	0.045	0.055	1.143	1.397
H	0.575	0.625	14.605	15.875
J1	0.080	0.120	2.032	3.048
K	0.045	0.066	1.143	1.676
L1	0.090	0.110	2.286	2.794
theta 1	3°	10°	3°	10°
theta 2	1°	7°	1°	7°
theta 3	0°	8°	0°	8°
theta 4	18°	22°	18°	22°
Q	0.055	0.075	1.397	1.905
U	0.256	Ref.	6.502	Ref.
V	0.305	Ref.	7.747	Ref.

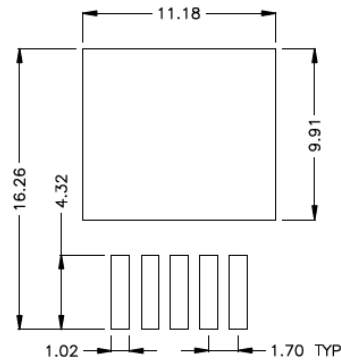

RECOMMENDED LAND PATTERN
(UNIT : mm)

- NOTE:
1. PACKAGE OUTLINE EXCLUSIVE OF MOLD FLASH & METAL BURR.
 2. PACKAGE OUTLINE INCLUSIVE OF PLATING THICKNESS.
 3. FOOT LENGTH USING GAUGE PLANE METHOD MEASUREMENT 0.010"
 4. PACKAGE TOP MARK MAY BE IN TOP CENTER OR LOWER LEFT CORNER
 5. ALL DIMENSIONS ARE IN INCHES/MILLIMETERS.

Note: For the most current package drawings, please see the Microchip Packaging Specification located at <http://www.microchip.com/packaging>.

APPENDIX A: REVISION HISTORY

Revision A (April 2018)

- Converted Micrel document MIC2940A/41A to Microchip data sheet DS20006000A.
- Minor text changes throughout.
- Corrected bold values in [Electrical Characteristics](#) table.

Revision B (February 2022)

- Updated the [Package Marking Information](#) drawings with the most current marking information.

MIC2940A/41A

NOTES:

MIC2940A/41A

PRODUCT IDENTIFICATION SYSTEM

To order or obtain information, e.g., on pricing or delivery, contact your local Microchip representative or sales office.

Device	-X.X	X	X	-XX
Part No.	Output Voltage	Junction Temp. Range	Package	Media Type
Device:	MIC2940A:	1.25A Low Dropout Voltage Regulator, Fixed Output Voltage		
	MIC2941A:	1.25A Low Dropout Voltage Regulator, Adjustable Output Voltage + Shutdown		
Output Voltage:	3.3 =	3.3V (MIC2940A only)		
	5.0 =	5.0V (MIC2940A only)		
	12 =	12V (MIC2940A only)		
	<blank>=	Adjustable (MIC2941A only)		
Junction Temperature Range:	W =	-40°C to +125°C, RoHS-Compliant*		
Package:	T =	3-Lead TO-220 (MIC2940A)		
	U =	5-Lead TO-220 (MIC2941A)		
		3-Lead TO-263 (MIC2940A)		
		5-Lead TO-263 (MIC2941A)		
Media Type:	<blank>=	50/Tube		
	TR =	750/Reel (TO-263 Package only)		

* RoHS-compliant with "high-melting solder" exemption.

Examples:

- a) MIC2940A-3.3WT: MIC2940A, 3.3V Output Voltage, -40°C to +125°C Temperature Range, 3-Lead TO-220, 50/Tube
- b) MIC2940A-3.3WU-TR: MIC2940A, 3.3V Output Voltage, -40°C to +125°C Temperature Range, 3-Lead TO-263, 750/Reel
- c) MIC2940A-5.0WU: MIC2940A, 5.0V Output Voltage, -40°C to +125°C Temperature Range, 3-Lead TO-263, 50/Tube
- d) MIC2940A-12WT: MIC2940A, 12V Output Voltage, -40°C to +125°C Temperature Range, 3-Lead TO-220, 50/Tube
- e) MIC2940A-12WU-TR: MIC2940A, 12V Output Voltage, -40°C to +125°C Temperature Range, 3-Lead TO-263, 750/Reel
- f) MIC2941AWT: MIC2941A, Adjustable Output Voltage, -40°C to +125°C Temperature Range, 3-Lead TO-220, 50/Tube
- g) MIC2941AWU: MIC2941A, Adjustable Output Voltage, -40°C to +125°C Temperature Range, 5-Lead TO-263, 50/Tube
- h) MIC2941AWU-TR: MIC2941A, Adjustable Output Voltage, -40°C to +125°C Temperature Range, 5-Lead TO-263, 750/Reel

Note 1: Tape and Reel identifier only appears in the catalog part number description. This identifier is used for ordering purposes and is not printed on the device package. Check with your Microchip Sales Office for package availability with the Tape and Reel option.

MIC2940A/41A

NOTES:

Note the following details of the code protection feature on Microchip products:

- Microchip products meet the specifications contained in their particular Microchip Data Sheet.
- Microchip believes that its family of products is secure when used in the intended manner, within operating specifications, and under normal conditions.
- Microchip values and aggressively protects its intellectual property rights. Attempts to breach the code protection features of Microchip product is strictly prohibited and may violate the Digital Millennium Copyright Act.
- Neither Microchip nor any other semiconductor manufacturer can guarantee the security of its code. Code protection does not mean that we are guaranteeing the product is “unbreakable”. Code protection is constantly evolving. Microchip is committed to continuously improving the code protection features of our products.

This publication and the information herein may be used only with Microchip products, including to design, test, and integrate Microchip products with your application. Use of this information in any other manner violates these terms. Information regarding device applications is provided only for your convenience and may be superseded by updates. It is your responsibility to ensure that your application meets with your specifications. Contact your local Microchip sales office for additional support or, obtain additional support at <https://www.microchip.com/en-us/support/design-help/client-support-services>.

THIS INFORMATION IS PROVIDED BY MICROCHIP "AS IS". MICROCHIP MAKES NO REPRESENTATIONS OR WARRANTIES OF ANY KIND WHETHER EXPRESS OR IMPLIED, WRITTEN OR ORAL, STATUTORY OR OTHERWISE, RELATED TO THE INFORMATION INCLUDING BUT NOT LIMITED TO ANY IMPLIED WARRANTIES OF NON-INFRINGEMENT, MERCHANTABILITY, AND FITNESS FOR A PARTICULAR PURPOSE, OR WARRANTIES RELATED TO ITS CONDITION, QUALITY, OR PERFORMANCE.

IN NO EVENT WILL MICROCHIP BE LIABLE FOR ANY INDIRECT, SPECIAL, PUNITIVE, INCIDENTAL, OR CONSEQUENTIAL LOSS, DAMAGE, COST, OR EXPENSE OF ANY KIND WHATSOEVER RELATED TO THE INFORMATION OR ITS USE, HOWEVER CAUSED, EVEN IF MICROCHIP HAS BEEN ADVISED OF THE POSSIBILITY OR THE DAMAGES ARE FORESEEABLE. TO THE FULLEST EXTENT ALLOWED BY LAW, MICROCHIP'S TOTAL LIABILITY ON ALL CLAIMS IN ANY WAY RELATED TO THE INFORMATION OR ITS USE WILL NOT EXCEED THE AMOUNT OF FEES, IF ANY, THAT YOU HAVE PAID DIRECTLY TO MICROCHIP FOR THE INFORMATION.

Use of Microchip devices in life support and/or safety applications is entirely at the buyer's risk, and the buyer agrees to defend, indemnify and hold harmless Microchip from any and all damages, claims, suits, or expenses resulting from such use. No licenses are conveyed, implicitly or otherwise, under any Microchip intellectual property rights unless otherwise stated.

For information regarding Microchip's Quality Management Systems, please visit www.microchip.com/quality.

Trademarks

The Microchip name and logo, the Microchip logo, Adaptec, AnyRate, AVR, AVR logo, AVR Freaks, BesTime, BitCloud, CryptoMemory, CryptoRF, dsPIC, flexPWR, HELDO, IGLOO, JukeBlox, KeeLoq, Klear, LANCheck, LinkMD, maXStylus, maXTouch, MediaLB, megaAVR, Microsemi, Microsemi logo, MOST, MOST logo, MPLAB, OptoLyzer, PIC, picoPower, PICSTART, PIC32 logo, PolarFire, Prochip Designer, QTouch, SAM-BA, SenGenuity, SpyNIC, SST, SST Logo, SuperFlash, Symmetricom, SyncServer, Tachyon, TimeSource, tinyAVR, UNI/O, Vectron, and XMEGA are registered trademarks of Microchip Technology Incorporated in the U.S.A. and other countries.

AgileSwitch, APT, ClockWorks, The Embedded Control Solutions Company, EtherSynch, Flashtec, Hyper Speed Control, HyperLight Load, IntelliMOS, Libero, motorBench, mTouch, Powermite 3, Precision Edge, ProASIC, ProASIC Plus, ProASIC Plus logo, QuietWire, SmartFusion, SyncWorld, Temux, TimeCesium, TimeHub, TimePictra, TimeProvider, TrueTime, WinPath, and ZL are registered trademarks of Microchip Technology Incorporated in the U.S.A.

Adjacent Key Suppression, AKS, Analog-for-the-Digital Age, Any Capacitor, AnyIn, AnyOut, Augmented Switching, BlueSky, BodyCom, CodeGuard, CryptoAuthentication, CryptoAutomotive, CryptoCompanion, CryptoController, dsPICDEM, dsPICDEM.net, Dynamic Average Matching, DAM, ECAN, Espresso T1S, EtherGREEN, GridTime, IdealBridge, In-Circuit Serial Programming, ICSP, INICnet, Intelligent Paralleling, Inter-Chip Connectivity, JitterBlocker, Knob-on-Display, maxCrypto, maxView, memBrain, Mindi, MiWi, MPASM, MPF, MPLAB Certified logo, MPLIB, MPLINK, MultiTRAK, NetDetach, NVM Express, NVMe, Omniscient Code Generation, PICDEM, PICDEM.net, PICkit, PICtail, PowerSmart, PureSilicon, QMatrix, REAL ICE, Ripple Blocker, RTAX, RTG4, SAM-ICE, Serial Quad I/O, simpleMAP, SimpliPHY, SmartBuffer, SmartHLS, SMART-I.S., storClad, SQI, SuperSwitcher, SuperSwitcher II, Switchtec, SynchroPHY, Total Endurance, TSHARC, USBCheck, VariSense, VectorBlox, VeriPHY, ViewSpan, WiperLock, XpressConnect, and ZENA are trademarks of Microchip Technology Incorporated in the U.S.A. and other countries.

SQTP is a service mark of Microchip Technology Incorporated in the U.S.A.

The Adaptec logo, Frequency on Demand, Silicon Storage Technology, Symmcom, and Trusted Time are registered trademarks of Microchip Technology Inc. in other countries.

GestIC is a registered trademark of Microchip Technology Germany II GmbH & Co. KG, a subsidiary of Microchip Technology Inc., in other countries.

All other trademarks mentioned herein are property of their respective companies.

© 2018 - 2022, Microchip Technology Incorporated and its subsidiaries.

All Rights Reserved.

ISBN: 978-1-5224-9780-6



MICROCHIP

Worldwide Sales and Service

AMERICAS

Corporate Office
2355 West Chandler Blvd.
Chandler, AZ 85224-6199
Tel: 480-792-7200
Fax: 480-792-7277
Technical Support:
<http://www.microchip.com/support>
Web Address:
www.microchip.com

Atlanta
Duluth, GA
Tel: 678-957-9614
Fax: 678-957-1455

Austin, TX
Tel: 512-257-3370

Boston
Westborough, MA
Tel: 774-760-0087
Fax: 774-760-0088

Chicago
Itasca, IL
Tel: 630-285-0071
Fax: 630-285-0075

Dallas
Addison, TX
Tel: 972-818-7423
Fax: 972-818-2924

Detroit
Novi, MI
Tel: 248-848-4000

Houston, TX
Tel: 281-894-5983

Indianapolis
Noblesville, IN
Tel: 317-773-8323
Fax: 317-773-5453
Tel: 317-536-2380

Los Angeles
Mission Viejo, CA
Tel: 949-462-9523
Fax: 949-462-9608
Tel: 951-273-7800

Raleigh, NC
Tel: 919-844-7510

New York, NY
Tel: 631-435-6000

San Jose, CA
Tel: 408-735-9110
Tel: 408-436-4270

Canada - Toronto
Tel: 905-695-1980
Fax: 905-695-2078

ASIA/PACIFIC

Australia - Sydney
Tel: 61-2-9868-6733

China - Beijing
Tel: 86-10-8569-7000

China - Chengdu
Tel: 86-28-8665-5511

China - Chongqing
Tel: 86-23-8980-9588

China - Dongguan
Tel: 86-769-8702-9880

China - Guangzhou
Tel: 86-20-8755-8029

China - Hangzhou
Tel: 86-571-8792-8115

China - Hong Kong SAR
Tel: 852-2943-5100

China - Nanjing
Tel: 86-25-8473-2460

China - Qingdao
Tel: 86-532-8502-7355

China - Shanghai
Tel: 86-21-3326-8000

China - Shenyang
Tel: 86-24-2334-2829

China - Shenzhen
Tel: 86-755-8864-2200

China - Suzhou
Tel: 86-186-6233-1526

China - Wuhan
Tel: 86-27-5980-5300

China - Xian
Tel: 86-29-8833-7252

China - Xiamen
Tel: 86-592-2388138

China - Zhuhai
Tel: 86-756-3210040

ASIA/PACIFIC

India - Bangalore
Tel: 91-80-3090-4444

India - New Delhi
Tel: 91-11-4160-8631

India - Pune
Tel: 91-20-4121-0141

Japan - Osaka
Tel: 81-6-6152-7160

Japan - Tokyo
Tel: 81-3-6880-3770

Korea - Daegu
Tel: 82-53-744-4301

Korea - Seoul
Tel: 82-2-554-7200

Malaysia - Kuala Lumpur
Tel: 60-3-7651-7906

Malaysia - Penang
Tel: 60-4-227-8870

Philippines - Manila
Tel: 63-2-634-9065

Singapore
Tel: 65-6334-8870

Taiwan - Hsin Chu
Tel: 886-3-577-8366

Taiwan - Kaohsiung
Tel: 886-7-213-7830

Taiwan - Taipei
Tel: 886-2-2508-8600

Thailand - Bangkok
Tel: 66-2-694-1351

Vietnam - Ho Chi Minh
Tel: 84-28-5448-2100

EUROPE

Austria - Wels
Tel: 43-7242-2244-39
Fax: 43-7242-2244-393

Denmark - Copenhagen
Tel: 45-4485-5910
Fax: 45-4485-2829

Finland - Espoo
Tel: 358-9-4520-820

France - Paris
Tel: 33-1-69-53-63-20
Fax: 33-1-69-30-90-79

Germany - Garching
Tel: 49-8931-9700

Germany - Haan
Tel: 49-2129-3766400

Germany - Heilbronn
Tel: 49-7131-72400

Germany - Karlsruhe
Tel: 49-721-625370

Germany - Munich
Tel: 49-89-627-144-0
Fax: 49-89-627-144-44

Germany - Rosenheim
Tel: 49-8031-354-560

Israel - Ra'anana
Tel: 972-9-744-7705

Italy - Milan
Tel: 39-0331-742611
Fax: 39-0331-466781

Italy - Padova
Tel: 39-049-7625286

Netherlands - Drunen
Tel: 31-416-690399
Fax: 31-416-690340

Norway - Trondheim
Tel: 47-7288-4388

Poland - Warsaw
Tel: 48-22-3325737

Romania - Bucharest
Tel: 40-21-407-87-50

Spain - Madrid
Tel: 34-91-708-08-90
Fax: 34-91-708-08-91

Sweden - Gothenberg
Tel: 46-31-704-60-40

Sweden - Stockholm
Tel: 46-8-5090-4654

UK - Wokingham
Tel: 44-118-921-5800
Fax: 44-118-921-5820